

# Melon Spikes

## Chapter 1

### Fireworks Mixers JNQ00275-B-002

#### GROUP B2: SPIKE INSTRUCTIONS

**Ziploc Storage Bags:** One storage bag is required to complete these instructions. This package includes enough papers for (40) units, but you only need (36).

- Block Group Bag B1: (10) Unit B2.
- Block Group Bag B2: (10) Unit B2.
- Block Group Bag B3: (8) Unit B2.
- Block Group Bag B4: (8) Unit B2.
- Template Bag B00-2: (5) each T-Temp A1, & C-1, (TLS) #1, #2, & #3 and (4) each Unit B2.

#### ► Preparing Foundation Papers & Templates:

Cut out (36) Unit B2, foundation papers [NP 866]. The foundation units are divided into the four Color Group Bags listed above. Place (10) each in Color Group Bags # B1 & B2, then Place (8) each into Color Group Bags B3 & B4. The remaining (4) B2 Units are placed with the T-Templates and Template Layout Sheets (TLS) 1, 2, & 3, in Template Bag B-002. The Templates are removed from the Template Bag during the cutting process. See the newsprint graphics for assigned Unit and Template names. \*Refer back to General Information under Foundation Papers and Templates for instructions on how to prepare your foundation papers and templates.

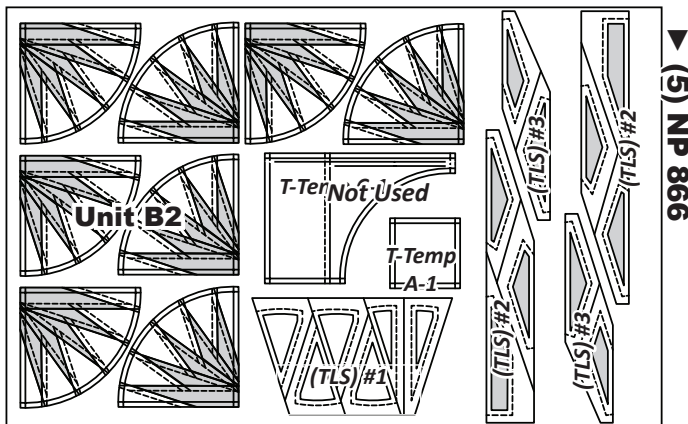

**NOTE -** The (4) extra B2 Units, and T-Temp C-1 and A-1 (on NP 866) are not used in Geodes. See Page 23 for optional ways to use the extra blocks in this pattern and T-Temp C-1, if you would like to make a companion project.

#### ► Color Group Layout

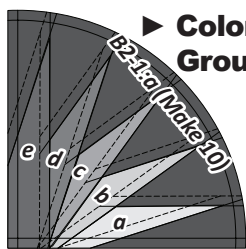

Spike Group B2-2:a-e(1)  
Green, Lime, Yellow, Peach, Red

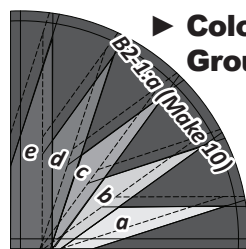

Spike Group B2-2:a-e(2)  
Pink, Purple, Blue, Teal, Cyan

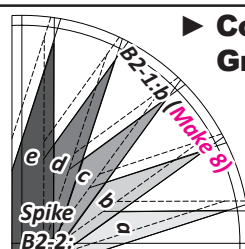

Spike Group B2-2:a-e(1)  
Green, Lime, Yellow, Peach, Red

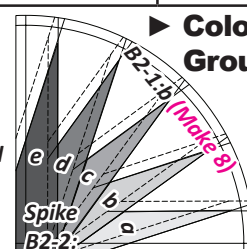

Spike Group B2-2:a-e(2)  
Pink, Purple, Blue, Teal, Cyan

#### Unit B2: (36) Blocks

GROUP-B2 FABRIC #	YARDAGE INCH	FABRIC SWATCH
Fabric B2-1:a Unit B2 (TLS) #1	7/8 yd or (30")	Black Fabric B2-1:a
	Cut (5) 6" Strips	
Fabric B2-1:b Unit B2 (TLS) #1	3/4 yd or (24")	White Fabric B2-1:b
	Cut (4) 6" Strips	
Fabric B2-2:a(1) Spikes Unit B2 Templates (B-2, B-4, B-6, B-8, B-10)	1/4 yd or (7-1/2")	Green Fabric B2-2:a(1)
	Cut (3) 2-1/2" Strips	
Fabric B2-2:a(2) Spikes Unit B2 Templates (B-2, B-4, B-6, B-8, B-10)	1/4 yd or (7-1/2")	Pink Fabric B2-2:a(2)
	Cut (3) 2-1/2" Strips	
Fabric B2-2:b(1) Spikes Unit B2 Templates (B-2, B-4, B-6, B-8, B-10)	1/4 yd or (7-1/2")	Lime Fabric B2-2:b(1)
	Cut (3) 2-1/2" Strips	
Fabric B2-2:b(2) Spikes Unit B2 Templates (B-2, B-4, B-6, B-8, B-10)	1/4 yd or (7-1/2")	Purple Fabric B2-2:b(2)
	Cut (3) 2-1/2" Strips	
Fabric B2-2:c(1) Spikes Unit B2 Templates (B-2, B-4, B-6, B-8, B-10)	1/4 yd or (7-1/2")	Gold Fabric B2-2:c(1)
	Cut (3) 2-1/2" Strips	
Fabric B2-2:c(2) Spikes Unit B2 Templates (B-2, B-4, B-6, B-8, B-10)	1/4 yd or (7-1/2")	Blue Fabric B2-2:c(2)
	Cut (3) 2-1/2" Strips	
Fabric B2-2:d(1) Spikes Unit B2 Templates (B-2, B-4, B-6, B-8, B-10)	1/4 yd or (7-1/2")	Peach Fabric B2-2:d(1)
	Cut (3) 2-1/2" Strips	
Fabric B2-2:d(2) Spikes Unit B2 Templates (B-2, B-4, B-6, B-8, B-10)	1/4 yd or (7-1/2")	Teal Fabric B2-2:d(2)
	Cut (3) 2-1/2" Strips	
Fabric B2-2:e(1) Spikes Unit B2 Templates (B-2, B-4, B-6, B-8, B-10)	1/4 yd or (7-1/2")	Red Fabric B2-2:e(1)
	Cut (3) 2-1/2" Strips	
Fabric B2-2:e(2) Spikes Unit B2 Templates (B-2, B-4, B-6, B-8, B-10)	1/4 yd or (7-1/2")	Cyan Fabric B2-2:e(2)
	Cut (3) 2-1/2" Strips	

**Fabric Information and Color Layout:** The *Unit Chart* on the previous page includes yardage, total inches, # of cut strips, fabric references, and the Cutting Templates that go with each Fabric # for Unit B2. Fabrics B2-1:a [black] and B2-1:b [white] are assigned to the background sections. Fabrics B2-2:a(1) to :e(1) are assigned to half the the spikes. (10) are paired with the B2-1:a black background and (8) are paired with the B2-1:b white background. Fabrics B2-2:a(2) to :e(2) are assigned to the spikes as well. Again, (10) are paired with the :a black and (8) with the :b white background fabrics. It is a good idea to add fabric swatches to the yardage chart to help you identify the assigned fabric # with your chosen fabric colors.

**GROUP B2: CUTTING INSTRUCTIONS**

**NOTE - Stacking Strips:** Always stack the strips in reverse alpha-numeric order when working with multiple colors, ending with the :a fabric on top of the :b fabrics.

**NOTE - Templates and (TLS):** Templates are repositioned on the cut strips to achieve the number of cuts required in the cutting instructions. Please read carefully to ensure the correct # of pieces are stacked beneath each Template before cutting.

**► Fabric B2-1:a & B2-1:b: Strip Cutting**

One 6” by 42” strip yields enough fabric to cut (4) pieces matching the size and shape of (TLS #1).

- **Two Color Option:** Cut (5) strips from Fabric B2-1:a [black] and (4) strips from B2-1:b [white]. Cut (20) pieces using (TLS #1) from B2-1:a and (16) pieces from B2-1:b.
- Remove (4) of the Unit B2 (TLS) #1 from Template Bag B-002.

**► Fabric B2-1:a & B2-1:a: (TLS) #1**

**Step 1:** The (9) strips are stacked facing *right-side-up*.



Stack (9) strips, (4) from B2-1:b on the bottom and (5) from B2-1:a on the top. Cut (4) stacks of (9) pieces.

**Step 2:** Unit B2, Template Layout Sheet #1 is used to sub-cut (4) stacks of (9) pieces matching the size and shape of the (TLS).

**Step 3:** The fabric pieces are then sorted and re stacked into (2) sets of (10) Fabric B2-1:a and (2) sets of (8) Fabric B2-1:b. Place (1) TLS #1 on the top of each stack.

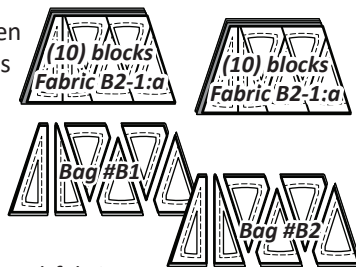

**Step 4:** To complete the cutting, slice through the paper and fabric on each Cut Line. Clip the pieces together and place into Their assigned Block Group Bags.

- Bag B1: (10) Fabric B2-1.a.
- Bag B2: (10) Fabric B2-1.a.
- Bag B3: (8) Fabric B2-1.b.
- Bag B4: (8) Fabric B2-1b.

**► Preparing (TLS #2 & #3)**

Remove (6) each Unit B2 (TLS) #2 and (TLS) #3 from Template Bag B-002.

Template Layout Sheets #2 & #3 were designed to cut multiple Sec. Templates for the spikes from one color. Since we are using multiple colors for the spikes, both Unit B2 (TLS #2) and (TLS #3) are cut apart on Cut Lines 1 & 2, to separate the individual Sec. Temps on each layout sheet, prior to cutting out your fabrics. Each Sec. Temp is then assigned to a different Fabrics # B2-2:(a to e) Group (1) and B2-2:(a to e) Group (2). Example; Sec 1 to Fabric :a. Repositionable glue placed on the backside of each template makes it easier to reposition the templates for multiple cuts.

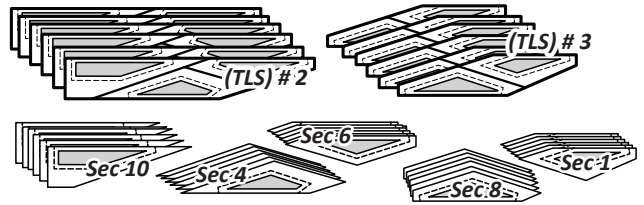

**► Fabric B2-2:a, b, c, d, e) Color Groups (1 & 2) (Temp B2, B4, B6, B8, B10)**

One 2-1/2” by 42” strip yields enough fabric to cut (6) Sec Templates matching the size and shape of each of the Sec Temp lates cut from (TLS #2 and (TLS) #3).

- **Two Color Option:** Cut (3) strips from Fabrics B2-2:a to e, from each Color Group (1) and (2). When you are done cutting you should have 18 pieces cut from each Sec. Temp from each Color Group.

**Step 1:** You should have (6) strips from each Fabric B2:a to B2:e, (3) from the group (1) fabric and (3) from the group (2) fabric. Stack the strips facing right-side-up. The strips cut from Color Group (2) or placed on the bottom of each stack. Color Group (1) on top.

**Step 2:** Pair each Sec. Template up with it’s assigned Fabric #, then cut (6) pieces from each strip to yield (18) pieces per color.

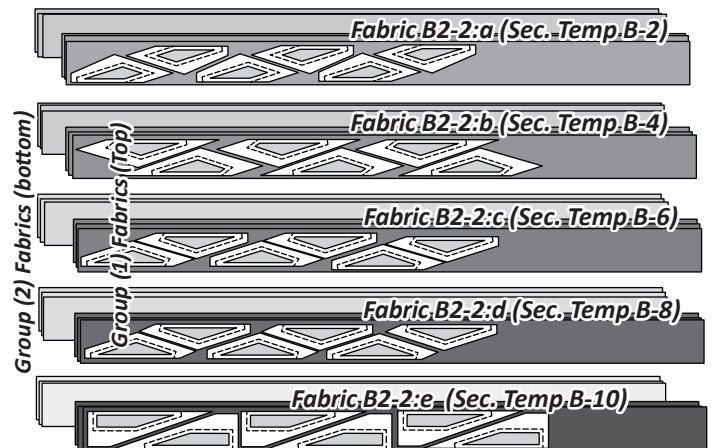

**Step 3:** After the cutting is completed for each template group, the fabric pieces are restack into (4) color groups;

- (10) of the Fabric B2-2:a to e, Color Group (1),
- (10) of the Fabric B2-2:a to e, Color Group, (2)
- (8) of the Fabric B2-2:a to e, Color Group (1)
- (8) of the Fabric B2-2:a to e, Color Group (2).

*Graphic follow on the next page.*

► **Finished Unit B2 Color Groups**

► **B2-1:a(Color Group 1) [Black Background]**  
**Make (10)**

- B2-2:a(1) [Green Spikes]
- B2-2:b(1) [Lime Spikes]
- B2-2:c(1) [Yellow Spikes]
- B2-2:d(1) [Orange Orange]
- B2-2:e(1) [Red Orange]

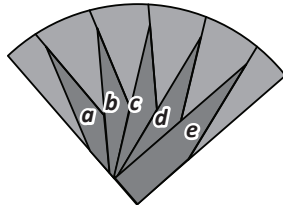

► **B2-1:b(Color Group 2) [Black Background]**  
**Make (10)**

- B2-2:a(2) [Pink Spikes]
- B2-2:b(2) [Purple Spikes]
- B2-2:c(2) [Blue Spikes]
- B2-2:d(2) [Teal Spikes]
- B2-2:e(2) [Cyan Spikes]

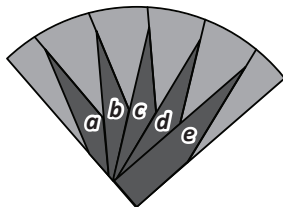

► **B2-1:a(Color Group 1) [White Background]**  
**Make (8)**

- B2-2:a(1) [Green Spikes]
- B2-2:b(1) [Lime Spikes]
- B2-2:c(1) [Yellow Spikes]
- B2-2:d(1) [Orange Orange]
- B2-2:e(1) [Red Orange]

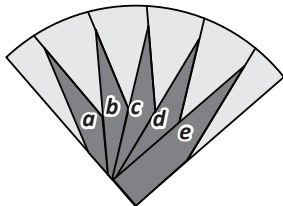

► **B2-1:b(Color Group 2) [White Background]**  
**Make (8)**

- B2-2:a(2) [Pink Spikes]
- B2-2:b(2) [Purple Spikes]
- B2-2:c(2) [Blue Spikes]
- B2-2:d(2) [Teal Spikes]
- B2-2:e(2) [Cyan Spikes]

