

GROUP B: STRIPED BORDER INSTRUCTIONS

Ziploc Storage Bags: You will need (4) bags to complete the organization for these instructions. Label the bags as follows to stay organized while cutting the Foundation Units and Templates.

- Bag #B1: (4) ea. Unit B1L, B2L, and B3L Foundation Papers.
- Bag #B2: (4) ea. Unit B1R, B2R, and B3R Foundation Papers.
- Bag #B3: (4) ea. Unit B4L, B5L, and B6L Foundation Papers.
- Bag #B4: (4) ea. Unit B4R, B5R, and B6R Foundation Papers.

Cut out (4) each of Units B4L–B6L and Units B4R–B6R on [NP 785]. Cut (4) each of Units B1L–B3L, Units B1R–B3R, and Template Layout Sheets #5 and #6 on [NP 786]. Cut (1) each of Template Layout Sheets #1 and #3 on [TP 580]. Cut (1) each of Template Layout Sheets #2 and #4 and Templates BR & BL 1, 3, & 4 on [TP 579]. The Templates and Template Layout Sheets (TLS) are cut out and placed temporarily in the B Group Bag. After the fabric has been cut the individual Sec. Templates are sorted and placed into their assigned Bag #s with the foundation papers. Reference the newsprint graphics for information when sorting the Units and Templates into bags. *Refer back to Introduction Booklet for additional instructions on how to prepare your foundation papers and templates.

Units B1R-1, B2R-1, B3R-1 Template Layout Sheet #1: These (3) templates have been grouped together onto one (TLS). When preparing these pieces, cut on the large dashed lines printed around the perimeter of the (3) templates. The templates are not separated until after the cutting is completed with your fabric.

Units B1L-1, B2L-1, B3L-1 Template Layout Sheet #2: These (3) templates have been grouped together onto one (TLS). When preparing these pieces, cut on the large dashed lines printed around the perimeter of the (3) templates. The templates are not separated until after the cutting is completed with your fabric.

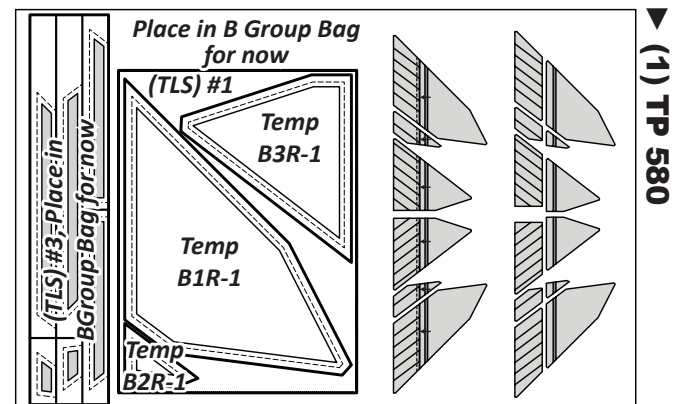
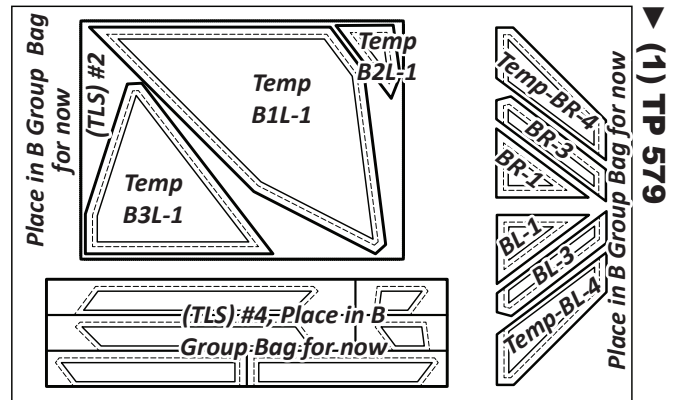
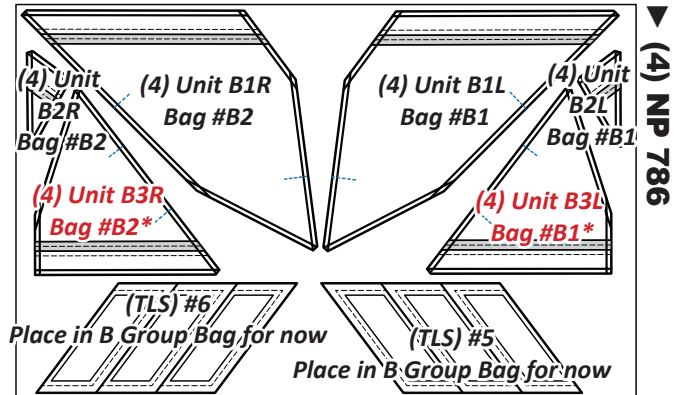

NOTE - On NP 786, Unit B3L and B3R, Sec. 3, was labeled with the wrong templates. They should say Sec. 3 B3L-3 and B3R-3. Please edit. We will fix on the next printing.

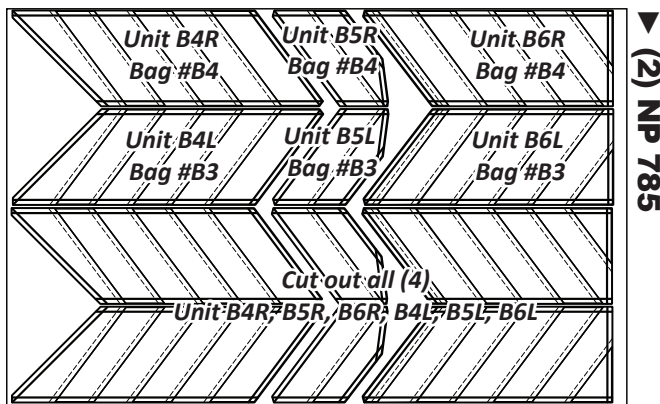

Fabric Swatch Color Layout

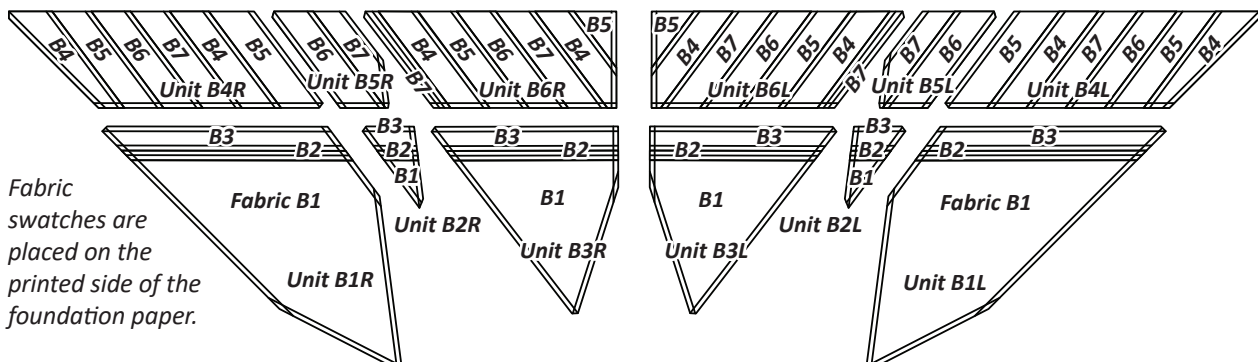

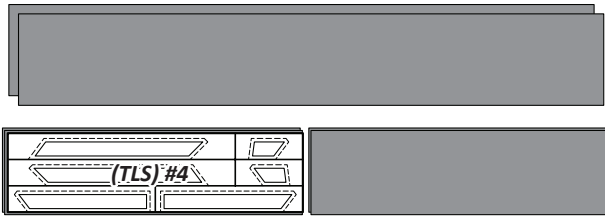

Step 1: The (4) pieces are stacked beneath the (TLS). Clip the paper templates to the fabric beneath. The cutting is completed by cutting on each Cut Line to separate the template pieces. Place the left templates in Bag #B1, right templates in Bag #B2.

NOTE - Make the noted changes on the TLS #4, also.

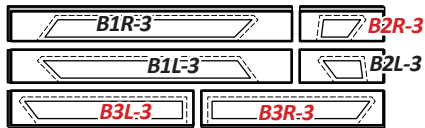
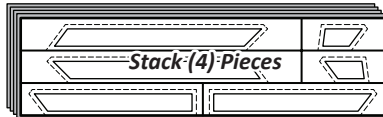

► **Fabric B4: (TLS #5 & #6, Temp BL-4 & BR-4)**

Step 1: Cut (4) 6" by 42" strips from Fabric B4. Stack the (4) strips facing *right-side-up*.

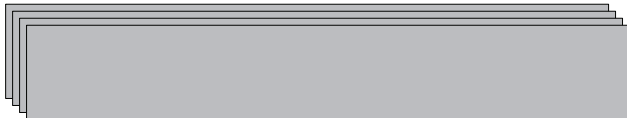

Step 2: Position *Temp BL-4*, (TLS) #5, (TLS) #6, and *Temp BR-4* on the stacked strips. Cut (4) single template pieces each of *Temp BL-4* and *Temp BR-4*. Cut the (4) strips even with edges of (TLS) #5 & #6; then cut on each Cut Line to separate the template pieces. Place the left templates in Bag #B3, right templates in Bag #B4.

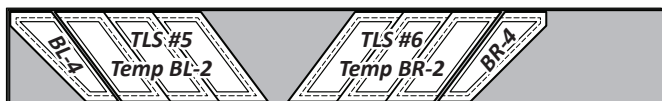

► **Fabric B5: (TLS #5 & #6, Temp BL-1 & BR-1)**

Step 1: Cut (4) 6" by 42" strips from Fabric B5. Stack the (4) strips facing *right-side-up*.

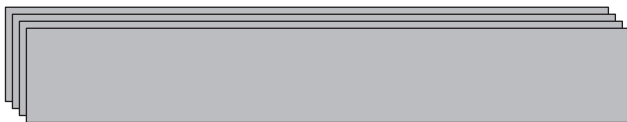

Step 2: Position *Temp BL-1*, (TLS) #5, (TLS) #6, and *Temp BR-1* on the stacked strips. Cut (4) single template pieces each of *Temp BL-1* and *Temp BR-1*. Cut the (4) strips even with edges of (TLS) #5 & #6; then cut on each Cut Line to separate the template pieces.

Place the left templates in Bag #B3, right templates in Bag #B4.

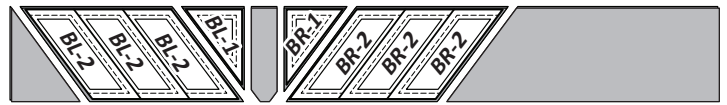
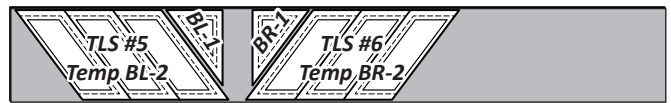

► **Fabric B6: (TLS #5 & #6)**

Step 1: Cut (4) 6" by 42" strips from Fabric B6. Stack the (4) strips facing *right-side-up*.



Step 2: Position (TLS) #5 & #6 on the stacked strips. Cut the (4) strips even with edges of (TLS) #5 & #6; then cut on each Cut Line to separate the template pieces. Place the left templates in Bag #B3, right templates in Bag #B4.

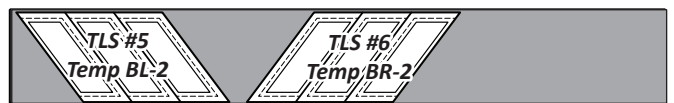

► **Fabric B7: (TLS #5 & #6, Temp BL-3 & BR-3)**

Step 1: Cut (4) 6" by 42" strips from Fabric B7. Stack the (4) strips facing *right-side-up*.



Step 2: Position *Temp BL-3*, (TLS) #5, (TLS) #6, and *Temp BR-3* on the stacked strips. Cut (4) single template pieces each of *Temp BL-3* and *Temp BR-3*. Cut the (4) strips even with edges of (TLS) #5 & #6; then cut on each Cut Line to separate the template pieces. Place the left templates in Bag #B3, right templates in Bag #B4.

