

Step 3: Stack (6) fabric pieces beneath each TLS. Cut on Line 1 to separate the individual template pieces. Place (12) each of *Sec Temp D2-2* and *Sec Temp D6-2* into *Bag #D1: (CG:a)*.

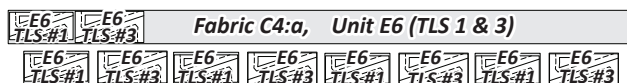

Step 4: Position (1) 2-1/4" by 42" strip facing *right-side-up*. One each *Unit E6-2 TLS #1* and *Unit E6-6 TLS #3* are used to cut (4) pieces matching the size of each TLS. Reposition the templates with each additional cut.



Step 5: Stack (4) fabric pieces beneath each TLS. Cut on Cut Line 1 to separate the individual template pieces. Place (8) each of *Sec Temp E2-2* and *Sec Temp D6-2* into *Bag #E4: (CG:a)*.



► **Fabric C4:b: Unit D6 & E6 TLS #1 & #3**

- *Unit D6-2, TLS #1 Unit D6-6, TLS #3*
- *Unit E6-2, TLS #1 Unit E6-6, TLS #3*

NOTE - Quiltster: If you precut your fabric strips using the *Quiltster APP*, you will need to sub-cut *Fabric C4:b*, into the (2) 2-1/4" by 42" strips, listed in *Step 1*.

Step 1: Cut (2) 2-1/4" by 42" strips from *Fabric C4:b*. Stack the strips facing *right-side-up*. Note: *TLS #1 & #3* from both (*Unit D6 & E6*) are used to cut the fabric pieces from these two strips.

Step 2: *Unit D6-2 TLS #1* and *Unit D6-6 TLS #3* are used to cut (6) fabric pieces matching the size of each TLS. Reposition the TLS for each additional cut. *Unit E6-2 TLS #1* and *Unit E6-6 TLS #3* are used to cut (2) fabric pieces matching the size of each TLS.

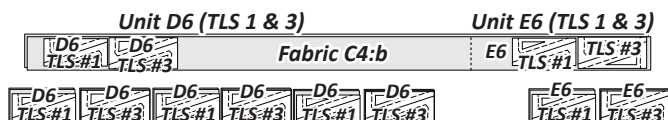

Step 3: Stack (6) fabric pieces beneath *Unit D6-2 TLS #1* and *Unit D6-6 TLS #3*. Cut on Cut Line 1 to separate the individual template pieces. Place (12) each of *Sec Temp D2-2* and *Sec Temp D6-2* into *Bag #D2: (CG:b)*.



Step 4: Stack (2) fabric pieces beneath *Unit E6-2 TLS #1* and *Unit E6-6 TLS #3*. Cut on Line 1 to separate the individual template pieces. Place (4) each *Sec Temp E2-2* and *Sec Temp E6-2* into *Bag #E5: (CG:b)*.



► **Fabric C5:a: Unit D6 & E6 TLS #6 & #8**

- *Unit D6-3 & D6-4, (TLS #6) Unit D6-7 & D6-8, (TLS #8)*
- *Unit E6-3 & E6-4, (TLS #6) Unit E6-7 & E6-8, (TLS #8)*

NOTE - Quiltster: If you precut your fabric strips using the *Quiltster APP*, you will need to sub-cut *Fabric C5:a*, into the (5) 6" by 42" strips, as listed in *Step 1*.

Step 1: Cut (5) 6" by 42" strips from *Fabric C5:a*. The first (3) strips are used to cut the *Unit D6 TLS* and the second (2) strips are used to cut the *Unit E6 TLS* listed above.

Step 2: Stack (3) 6" by 42" strips from *Fabric C5:a* facing *right-side-up*. One each *Unit D6-3 & D6-4 TLS #6* and *Unit D6-7 & D6-8 TLS #8* are used to cut (12) fabric pieces matching the size and shape of each TLS. Reposition the templates for each additional cut.

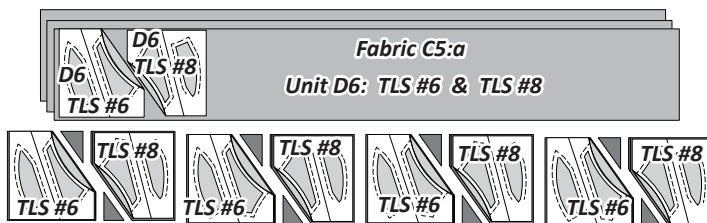

Step 3: Stack (12) fabric pieces beneath each TLS. Cut on Line 1 to separate the individual template pieces. Place (12) each of the *Unit D6, Sec Temps* into *Bag #D1: (CG:a)*.

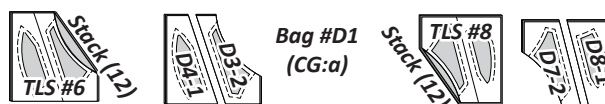

Step 4: Stack (2) 6" by 42" strips, *Fabric C5:a* facing *right-side-up*. One each *Unit E6-3 & E6-4 TLS #6* and *Unit E6-7 & E6-8 TLS #8* are used to cut (8) fabric pieces matching the size and shape of each TLS. Reposition the templates for each additional cut.

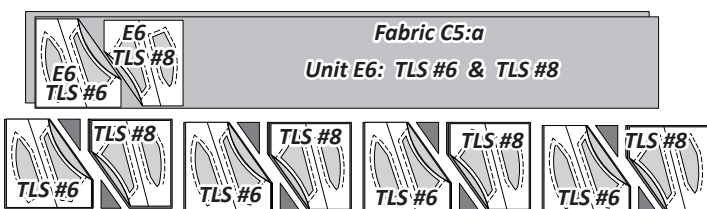

Step 5: Stack (8) fabric pieces beneath each TLS. Cut on Line 1 to separate the individual template pieces. Place (8) each of the *Unit E6, Sec Temps* into *Bag #E4: (CG:a)*.

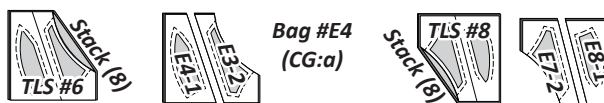

► **Fabric C5:b: Unit D6 & E6 TLS #6 & #8**

- *Unit D6-3 & D6-4, (TLS #6) Unit D6-7 & D6-8, (TLS #8)*
- *Unit E6-3 & E6-4, (TLS #6) Unit E6-7 & E6-8, (TLS #8)*

NOTE - Quiltster: If you precut your fabric strips using the *Quiltster APP*, you will need to sub-cut *Fabric C5:b*, into the (4) 6" by 42" strips, as listed in *Step 1*.

Step 1: Cut (4) 6" by 42" strips from *Fabric C5:b*. Place (3) strips with the *Unit D6 TLS's* listed above. Place (1) strip with the *Unit E6 TLS's* listed above.

PARTIAL SEAM ASSEMBLY GRAPHICS (CENTER BLOCK GROUPS)

The Center Block Groups are assembled using the fabric pieces cut with T-Temp A1 (corner stones) and the Unit D6 Block Groups. Look in Template Bag #B3 to find the corner stone templates.

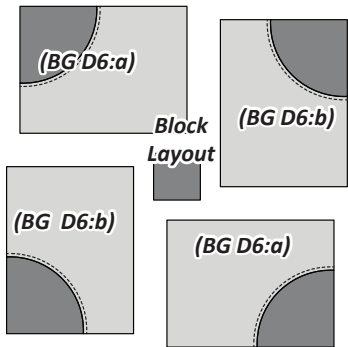

A partial seam construction process is used to join the rectangles to the corner stone. The seams are pressed in the same direction the arrows are pointing in the graphics. Also, please note that the images shown reflect the frontside of the block which appears, counter-clockwise on the front, clockwise on the back..

Assembly Graphic 1: Join the 1st Block Group D6:a, to the 3-1/2" square. A half seam is used to join the two pieces. Start at the corner of each square, sew into the center about 1-1/2" leaving the second half of the square unsewn. Press seam towards the square.

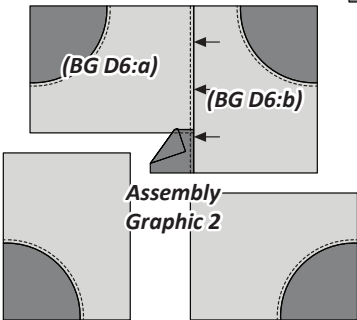
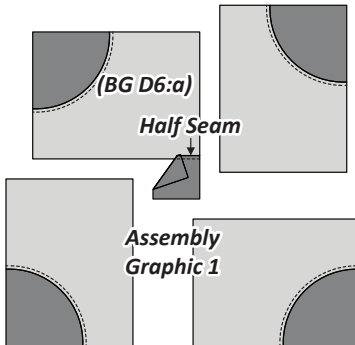

Assembly Graphic 2: Join Block Group D6:b onto Block Group D6:a. Press the seam towards the corner stone.

Assembly Graphic 3: Join Block Group D6:a onto Block Group D6:b. Press the seam towards the corner stone.

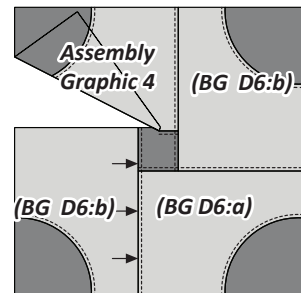
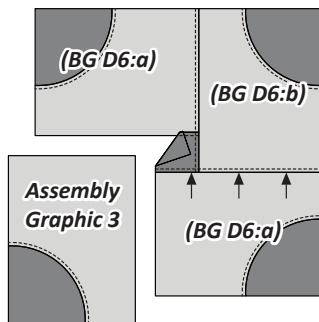

Assembly Graphic 4: Sew Block Group D6:b onto Block Group D6:a. Press seam towards the square.

Assembly Graphic 5: The partial seam is completed to finish the Block Group. Press seam towards the square.

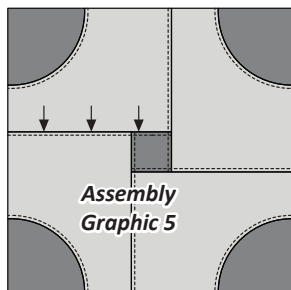

MACHINE INVISIBLE APPLIQUÉ

At this point, you will need to choose whether you plan to do Machine Invisible Appliqué, or Digitized Embroidery. If you are doing Digitized Embroidery and plan to use the cutting machine files in the Fabric Confetti pattern, see Page 18 for more information. You may want to wait to cut the strips for your appliqué. For Invisible appliqué techniques (or digitized embroidery with the Stitch-N-peel templates as your cutting guides), cut your appliqué strips at this time.

Yardage and cutting instructions are included on page 15. It's helpful to add fabric swatches to this table to stay organized. There's lots of colors to keep track of. Fabric layouts have been included on Page 15 to help you visualize placement of the template pieces on your strips.

▶ Cutting out your Appliqué Templates

Cutting the Stems and Leaves: A small rotary cutter is used to cut the tiny tabs that hold the template pieces into the 8-1/2" x 11" Cutout Sheets. Touch the tab with the blade of your rotary cutter and gently press the blade into the tab to remove the pieces. Once the template sections have been removed from the sheets set the pages aside, do not throw them away. You will use them to build your flower groups. They are also used to identify the template pieces after the turn under applique is completed. The stems come in several different lengths, so it is best to keep the different sizes separated.

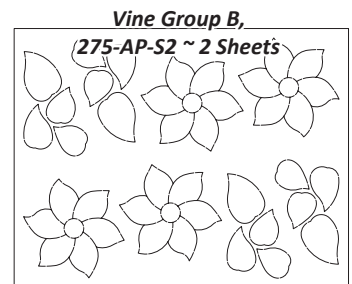
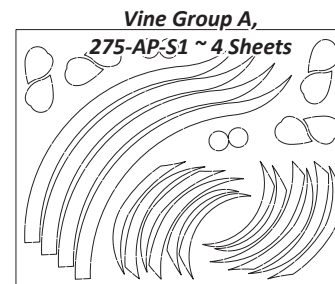
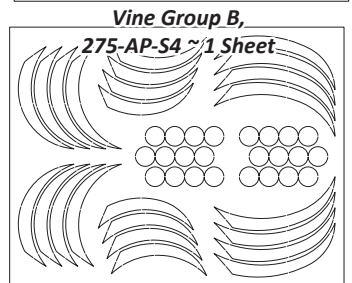
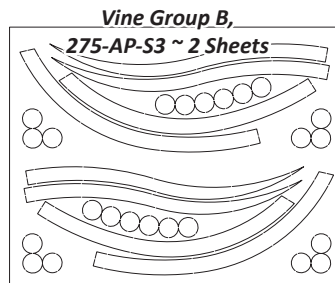
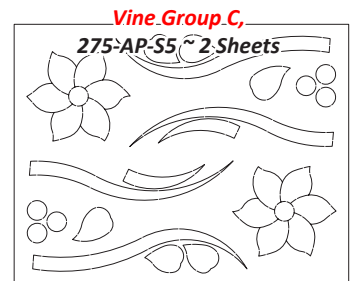

On pages 16 & 17, you will find larger graphics showing each of the layout sheets labeled with the identifier template names and Fabric #s. You can label them with the fabric reference #s to help stay organized as well. This will really make a difference if your pieces get mixed up.

Cutting out the Flowers: It is best to cut out around the whole flower, keeping the petals together, until you are ready to apply the pieces to your fabric. Once you are ready to apply the piece to the fabric, cut off each petal one at a time and place them with