

Fat Feathered Star Border

55-1/2" Star

JNQ00193-B-006 Snowfall Mixer Border

GROUP B: FAT FEATHERED STAR BORDER INSTRUCTIONS

Ziploc Storage Bags: You will need (2) Bag to complete the organization for these Instructions. Label Bag as follows:

- Bag #B1: (8) Unit B1, Foundation Papers
- Bag #B2: (8) Unit B2, Foundation Papers

► Preparing the Foundation Papers:

Foundation Papers: This chapter includes enough foundation papers to complete (8) Border Groups. The foundation papers and templates for this pattern are printed on newsprint. Newsprint is lightweight and tears away from your stitches without damaging the threads. Please pull apart this package and check, at this time, to make sure your pattern includes all of the newsprint listed below.

Cut out (8) of each Unit B1, and B2 found on [NP 853]. The associated Templates and Templates Layout Sheets on [TP 671] are cutout, and arranged in chronological order, then placed into a temporary bag. After the fabric has been cut the individual Sec. Templates are placed into assigned Bag #s with their associated foundation papers. See the newsprint graphics below for information on how to organize your units and templates into bags. *Refer back to General Information under Foundation Papers and Templates for additional instructions on how to prepare your foundation papers and templates.

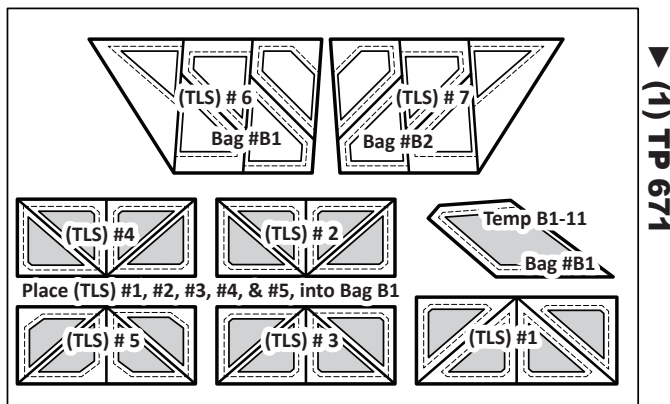
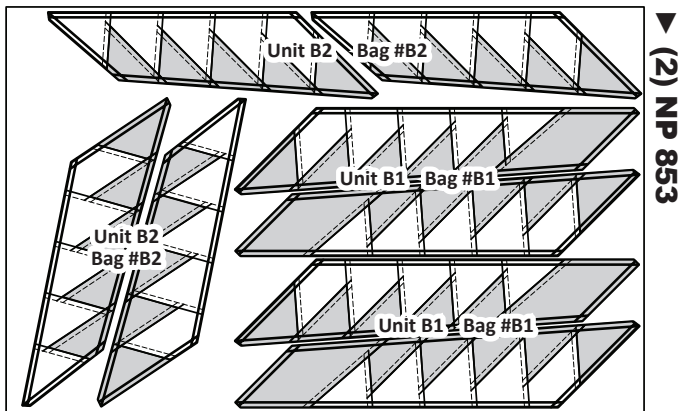

► Yardage Chart:

The yardage chart that follows includes yardage, fabric numbers, and a reference to which fabrics are assigned to the Template Layout Sheets to complete Units B1 & B2. The table is your guide for selecting colors, and keeping you organized. Don't forget to cut a swatch of your chosen fabric to paste in the box in the Assigned Colors column!

Standard Chart: Unit B1 & B2 Yardage: Make (8) Each

STANDARD GROUP-B FABRIC #	YARDAGE INCH	ASSIGNED COLOR
Background Fabric B1 Unit B1 & B2: (TLS) #6 & 7	7/8 yd or (28")	FABRIC SWATCH
Fabric B2 Unit B1 & B2: (TLS) #1	1/8 yd or (4-1/2")	FABRIC SWATCH
Fabric B3 Unit B1 & B2: (TLS) #2	1/8 yd or (4-1/4")	FABRIC SWATCH
Fabric B4 Unit B1 & B2: (TLS) #3	1/8 yd or (4-1/4")	FABRIC SWATCH
Fabric B5 Unit B1 & B2: (TLS) #4	1/8 yd or (4-1/4")	FABRIC SWATCH
Fabric B6 Unit B1 & B2: (TLS) #5	1/8 yd or (4-1/4")	FABRIC SWATCH
Fabric B7 Unit B1 & B2: Unit B1: Temp B1-11	1/4 yd or (8")	FABRIC SWATCH

► Color Layout

The color layout shown matches the printed side of the paper, and the backside of the quilt. If you used Quiltster you can translate the colors in Quiltster to the units below. If not, cut several small fabric swatches from each of your selected fabrics and use them to create your own color layout by arranging them in the triangle slots labeled B1-B7.

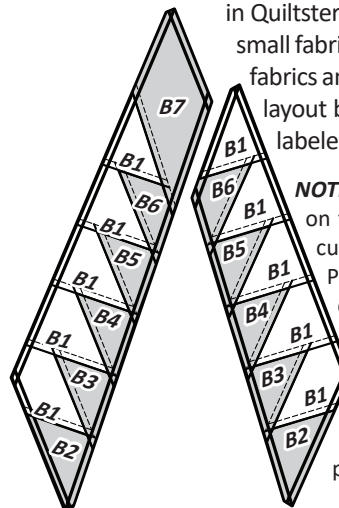

NOTE - Templates and (TLS) are repositioned on the cut strips to achieve the number of cuts required in the cutting Instructions. Please read carefully to ensure the correct # of pieces are stacked beneath each template before cutting.

NOTE - Repositionable glue placed on the backside of each template will keep the (TLS) from moving in the cutting process.

► **Fabric B1: Unit B1 & B2 Background (TLS) #6 & #7**

Step 1: Cut (4) 7" by 42" strips from Fabric B1. Stack the strips facing *right-side-up* on your table. **Unit B2 Background (TLS) #6 & #7**, are used to cut (8) pieces matching the size of each (TLS).

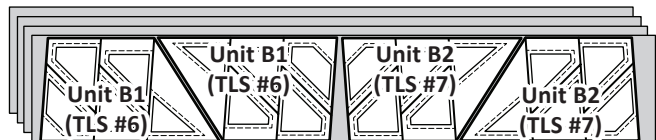

Step 2: The cutting is completed by slicing through the paper on each cut line to separate the individual sections. Paper clips are used to keep the fabric and template pieces together. Place the Unit B1 Templates in Bag #B1 and the Unit B2 Templates in Bag #B2.

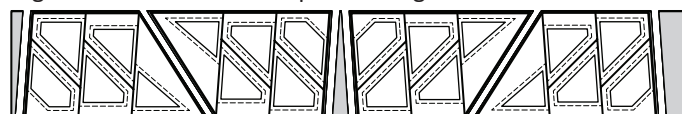

► **Fabric B2: (TLS) #1**

Step 1: Cut (1) 4-1/2" by 42" strip. Position the strip facing *right-side-up*. Use the **Unit B1 & B2 (TLS) #1** to sub-cut (4) rectangles matching the size of the (TLS).

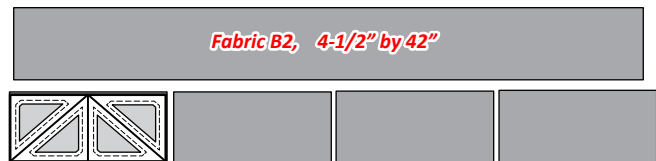

Step 2: The (4) rectangles are stacked beneath (TLS) #1. To complete the cutting slice through the paper and fabric on Cut Lines 1-3.

Step 3: Place the Unit B1 templates in Bag #B1 and the Unit B2 templates in Bag #B2.

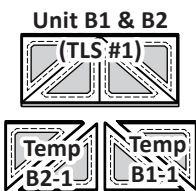

► **Fabric B3: (TLS) #2**

Step 1: Cut (1) 4-1/4" by 42" strips. Position the strip facing *right-side-up*. Use the **Unit B1 & B2 (TLS) #2** to sub-cut (4) rectangles matching the size of the (TLS).

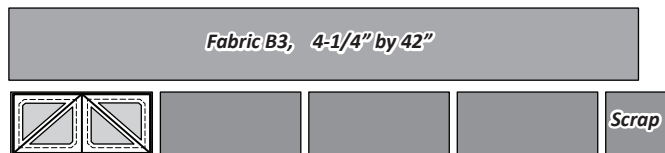

Step 2: The (4) rectangles are stacked beneath (TLS) #2. To complete the cutting slice through the paper and fabric on Cut Lines 1-3.

Step 3: Place the Unit B1 templates in Bag #B1 and the Unit B2 templates in Bag #B2.

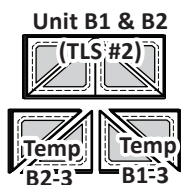

► **Fabric B4: (TLS) #3**

Step 1: Cut (1) 4-1/4" by 42" strips. Position the strip facing *right-side-up*. Use the **Unit B1 & B2 (TLS) #3** to sub-cut (4) rectangles matching the size of the (TLS).

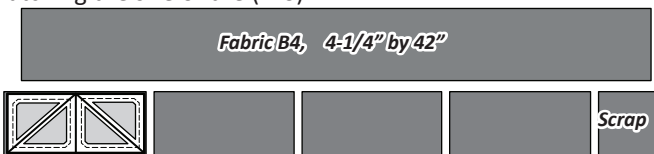

Step 2: The (4) rectangles are stacked beneath (TLS) #3. To complete the cutting slice through the paper and fabric on Cut Lines 1-3.

Step 3: Place the Unit B1 templates in Bag #B1 and the Unit B2 templates in Bag #B2.

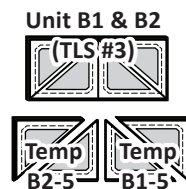

► **Fabric B5: (TLS) #4**

Step 1: Cut (1) 4-1/4" by 42" strips. Position the strip facing *right-side-up*. Use the **Unit B1 & B2 (TLS) #4** to sub-cut (4) rectangles matching the size of the (TLS).

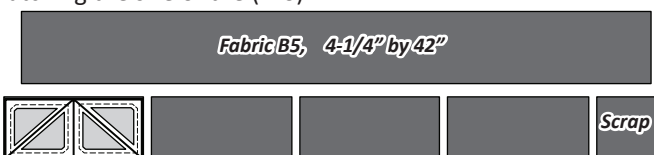

Step 2: The (4) rectangles are stacked beneath (TLS) #4. To complete the cutting slice through the paper and fabric on Cut Lines 1-3.

Step 3: Place the Unit B1 templates in Bag #B1 and the Unit B2 templates in Bag #B2.

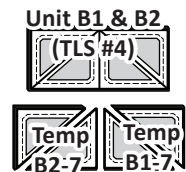

► **Fabric B6: (TLS) #5**

Step 1: Cut (1) 4-1/4" by 42" strips. Position the strip facing *right-side-up*. Use the **Unit B1 & B2 (TLS) #5** to sub-cut (4) rectangles matching the size of the (TLS).

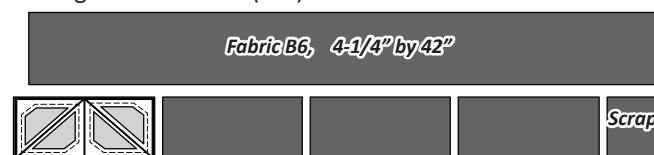

Step 2: The (4) rectangles are stacked beneath (TLS) #5. To complete the cutting slice through the paper and fabric on Cut Lines 1-3.

Step 3: Place the Unit B1 templates in Bag #B1 and the Unit B2 templates in Bag #B2.

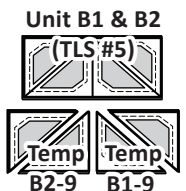

► **Fabric B7: Temp B1-11**

Step 1: Cut (2) 4" by 42" strips. Stack the strip facing *right-side-up*. **Unit B1 Temp B1-11** is used to cut (8) pieces.



Step 2: Place the Unit B1 templates in Bag #B1.

